

ONLY

Filter you need

Introducing our revolutionary **ONLY** Cartridge Filters,
for all your filtration needs.

Say Goodbye

To all other filters

ONLY FILTER

- **High flow rates**
- **Not costly**
- **Very efficient**
- **NO tools necessary**
- **Easy to handle**
- **High filtration surface**
- **Very easy servicing**
- **Long lasting cartridges**

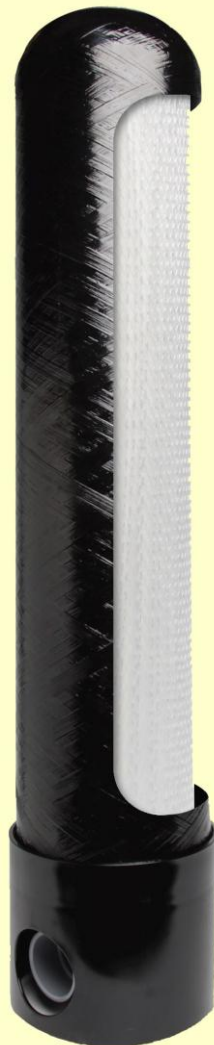

This pressure vessel is tested and Certified by WQA International against NSF/ANSI Standard 61 for materials and structural integrity requirements

COMPONENT

Other Filters

- **Low flow rates**
- **Costly**
- **Not efficient**
- **Tools required**
- **Difficult to handle**
- **Not good filtration surface**
- **Difficult servicing**
- **Monthly cartridge replacement**



Introducing our revolutionary new
ONLY Filtration Cartridges

Get rid of small and inefficient 2.5" or 4.5" plastic housings. The **ONLY Filtration Cartridges** is a corrosion-free liquid filtration solution offering extended life, service and chemical resistance.

It also has an easily accessible wide mouth opening so you can customize it with any of our filters.

Watch[®] GmbH

Table of Content

ONLY Cartridge Filtration System	3
Design Schematic	4
Connections for ONLY Filtration System	5
ONLY XL Cartridges Great Systems	7
System Description	8
BIG WHITE refillable Empty Cartridges	10
ONLY FILTRATION SERIES	11
DOUBLE PLEATED Filtration Series	12
UNIQUE Filtration Series	13
CARBON BLOCK Filter	14
WOUNDED Cartridge Filter	15
PLEATED Filtration Series	16
MELTBLOWN Filtration Series	17
EASY Ultra Filtration	18

ONLY Cartridge Filtration System

Say goodbye to small and inefficient housings. Get rid of expensive stainless steel housings. The **ONLY Cartridge Filter** offers extended life and service, and a more cost effective and efficient filtration solution.

This revolutionary, patent pending filtration system features easy to-access top and bottom openings for use with various filtration connections and solutions. Lightweight and cost effective with multiple configuration options, this is the filtration solution of the future...100% non-metallic!

Utilizing **ONLY** patented, industry exclusive liner design, the vessel features three optional top and bottom opening connections for use with a pressure release valve configuration or a control valve/in-out head, along with bottom or top drain plumbing connections for residential and light commercial installations. The patent pending, no-tools-required snap-ring design makes it easy to remove top and bottom opening connections to access the internal filtration solution. Full radial seal top and bottom caps make replacement simple.

The **ONLY Cartridge Filter** is a direct replacement for small and inefficient 2.5" or 4.5" housings, or expensive Stainless Steel cartridge housings.

Designed for fast and easy access, the Pressure Release top opening with plumbing connections at the bottom allows the end-user to access and service the filter without disrupting the plumbing. The **Cartridge Filter** is a high performance device and has been tested to 10 bar operating pressure.

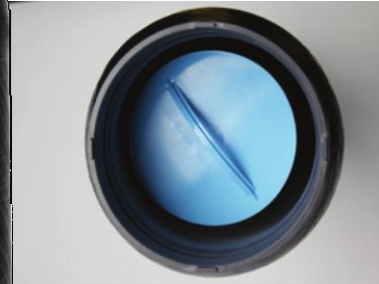

**ONLY CARTRIDGE
THE FILTER YOU NEED**

CARTRIDGE FILTER APPLICATIONS

- Whole house POE requirements whether for city or well water applications
- Extreme loading conditions, RO systems and any other pretreatment applications where high service flow and low pressure drop requirements are required or desirable
- For customers that are tired of having to change their small 2.5" or 4.5" filters on a weekly or monthly basis
- Replacement solution for expensive stainless steel housings 100% plastic design
- Ideal for most problem water issues where particulate contaminated water is concerned, with lower shear velocity these filters can load properly with particulates, unlike conventional filtration

ONLY is a Watch[®] Filtration Technology

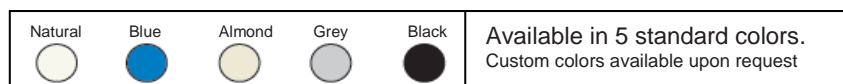

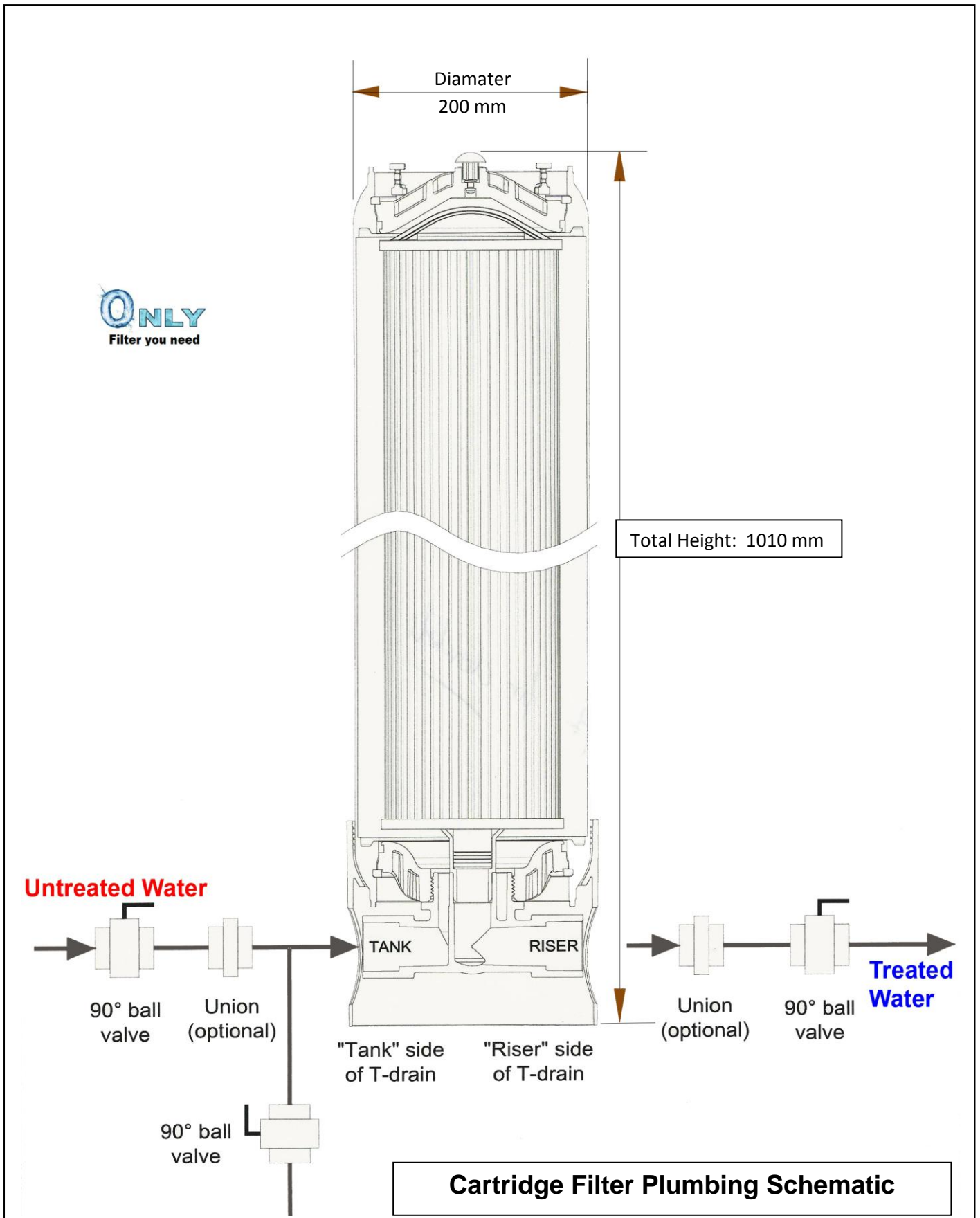

CONNECTIONS
FOR ONLY FILTRATION SYSTEM



Top cap with pressure vessel valve



Snap ring for Top & bottom caps



2 1/2" bottom cap



4" bottom cap



2 1/2" inlet-outlet connection



4" inlet-outlet connection





The 2.5" threaded PVC connection drain features a glue socket of 1.315" for multiple pipe requirement connections; while the 4.5" threaded PVC drain features a full 2.375" pipe socket connection.

All glue joints and connections are contained underneath and/or inside the vessel base, providing clean connections and visibly attractive system suitable for homeowners, businesses and consumers.

ONLY Cartridge Filtration System for Point-of-Entry (POE) installations and applications. With multiple configuration options, this is the filtration solution of the future. Features include:

Easy-to-access top and bottom opening for use with **multiple filtration connections** and solutions - in a lightweight and cost effective package.

100% non-metallic, multiple filtration solutions

Three optional top and bottom opening connections for use with a pressure release valve configuration, a control valve or in-out head, along with bottom or top drain plumbing connections for residential or light commercial installations...**extending the flexibility of the system to the end-user.**

2.5" threaded PVC connection drain **features a glue socket of 1.315"** for multiple pipe requirement connections; while the 4.5" threaded PVC drain **features a full 2.375"** pipe socket connection.

All glue joints and connections are contained underneath and inside the vessel base, for **clean connections and a visibly attractive Systems for homeowners, businesses and consumers.**

Patent pending no tools necessary snap-ring design makes it easy to access the internal filtration solution. Full radial seal top and bottom caps make replacement simple.

Ideal design for cartridge use is the **Pressure Release top opening with the plumbing connections at the bottom**, so the end-user does not have to disrupt plumbing to access and service the filter.

The ONLY Cartridge Filter is tested to 150 psi operating pressure for high performance



ONLY XL Cartridges
Great Systems

FOR Point-of-Entry

**S
Y
S
T
E
M
S**



- **Scale Prevention**
- **Corrosion Protection**
- **Arsenic Removal**
- **Lead Removal**
- **Copper Removal**
- **Phosphate Removal**
- **Uranium Removal**
- **Chromium Removal**
- **Flouride Removal**
- **Dosing Equipment**

ONLY XL Cartridges Great Systems

System Description:

The **WATCH[®]** Great **Point-Of-Entry** Systems are pre-piped systems which are designed to remove any contaminants from water and waste water.

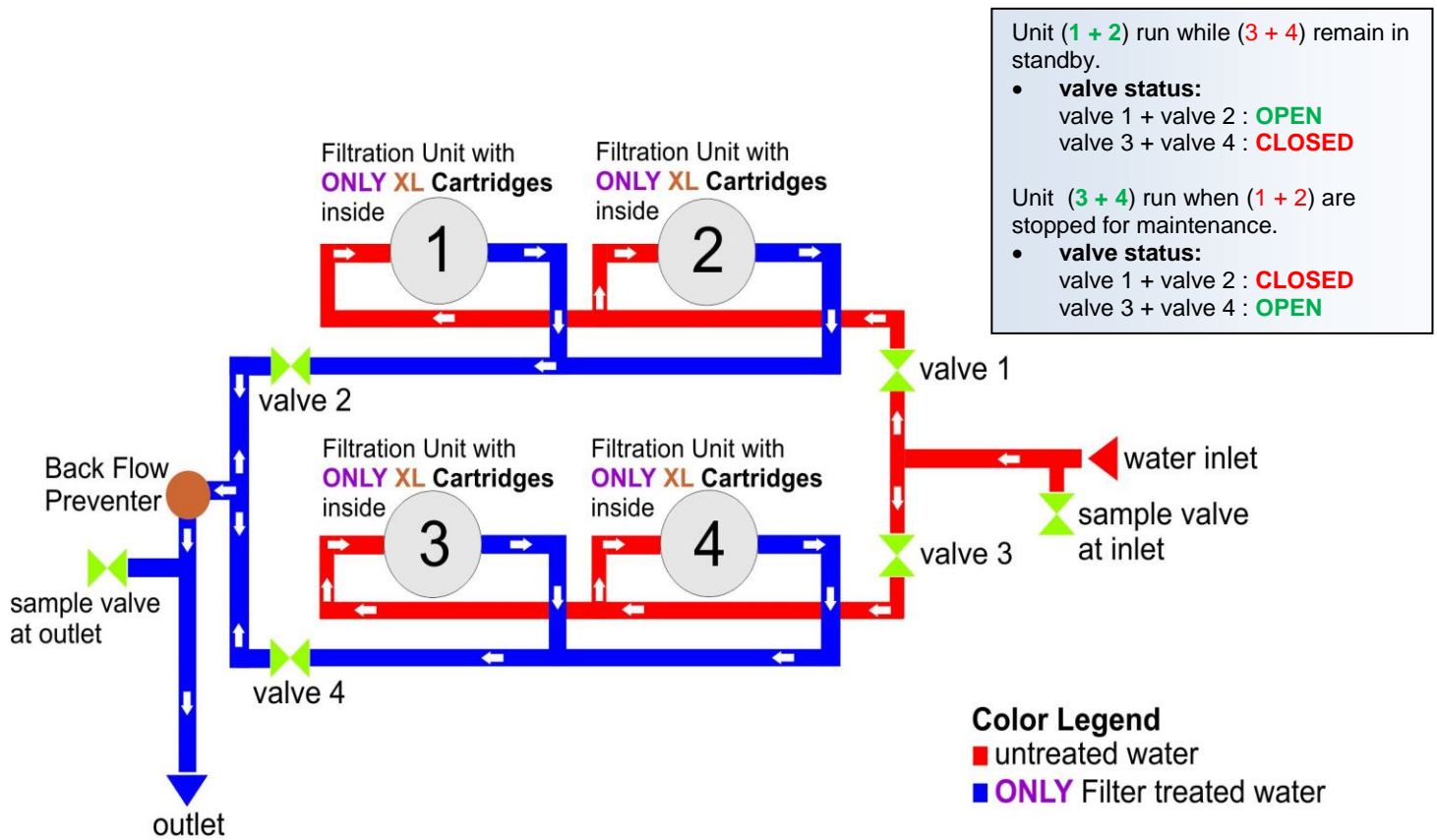

ONLY XL Cartridges Great System (Design Schematic)

It is Great because it consists of two complete (1 + 2) and (3 + 4) **ANYTHING removal** plug-and-play modular assemblies, piped together in series so that when the capacity of the first (1 + 2) system is exhausted, the second (3 + 4) system continues to provide treated water and the cartridges in the first system can be replaced with new filter media of choice. It is absolutely recommended to use pre-filters to remove any particular material entering with the feed water. The pre-filter is a 20, 10 or 5 micron filter cartridge. Use of 1 micron filter cartridge is recommended.

ONLY XL Cartridges **Great Systems**

Water **Great Systems** (1 + 2) and (3 + 4) are 8" diameter Filter housing, each containing a Double media cartridge. The units are pre-piped where (1 + 2) operate in parallel as an independent system. (3 + 4) also operate in parallel but is in stand-by mode and is used during the maintenance/servicing of (1 + 2). Depending on contaminant and application, each system produces a flow from 3 - 10 m³/hr. A proper operation of the overall system will maximize cartridge lifetime and minimize costs.

A booster pump with pressure tank and pressure switch can be provided if a drop in pressure is observed after the Great System.

All piping and ball valves are glued PVC. The inlet/outlet connections are 1", 1½" or 2" female sockets.

The **Great System** comes as a ready-to-use unit built on a Euro Pallet of dimension **80x120** cm.



The Biggest **XL** Refillable Cartridge

Description

Watch Water's biggest **XL** empty media cartridge in the world, that fits into the **ONLY FILTER** housing which is full of advantages that no other cartridges can have. **BIG WHITE** empty cartridges can be filled with your Filtration media, Ion exchange resins, mixed bed resins or any adsorbers of your choice in order to create a best choice of very high capacity filter on very low cost. Low cost products are having a huge demand in places where people have water full of contaminants. These are the cartridges for solving present and future water problems.

Advantages

No Valve.

No Regeneration.

No Waste water.

High Capacity.

The most advanced empty cartridges in the world.

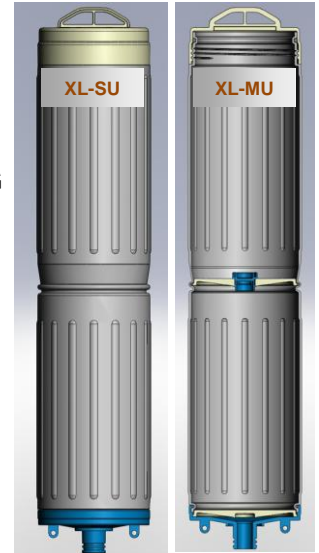

BIG - WHITE

LIST OF WATCH PRODUCTS

ITEM	PRODUCTS	APPLICATION	TYP	FLOW / HOUR (m ³ /hr)
BWSP	Filtersorb-SP3	Scale prevention	SP	0,5 – 3,0
BWSPA	Filtersorb-SP3 + Activated carbon	Scale prevention + Adsorber, Chlorine removal, odor and organic adsorption.	SPA	1,0
BWHS	Filtersorb-HSR	Removal of Hydrogen Sulphide, Phosphates, Copper, Lead and other Heavy Metals.	HS	2,0 (one cartridges) 3,0 (two cartridges)
BWT	Titansorb	Highest capacity, Arsenic and Heavy Metal removal	T	2,0
BWFL	Flashsorb	High capacity, Fluorides removal	FL	2,0
BWNC	NewClearsorb	Radionuclides, uranium, radium, cesium	NC	2,0
BWKL	Katalox - Light	Iron- Manganese + suspended solids up to 3 microns.	KL	1,0

OTHER PRODUCTS

BWMB	Mix bed resin	De-mineralisation	MB	2,0
BWCS	Cation resin (strong acid)	Softening	CS	2,0
BWCW	Dealkalisation	De-alkalisation	CW	2,0
BWNI	Anion exchange selective	Nitrates removal	NI	2,0

XL - Extra Large

WATCH[®] GmbH

Cartridge Filters

ONLY Filter Series

- **DOUBLE PLEATED Filtration Series**
- **UNIQUE Filtration Series**
- **CARBON BLOCK**
- **WOUNDED Cartridge Filters**
- **PLEATED Filtration Series**
- **MELTBLOWN Filtration Series**
- **EASY Ultra Filtration**

TYPE: **DOUBLE PLEATED** Filtration Series

ONLY simplifies the filtration process and offers a variety of options to suit your needs.

The **DOUBLE PLEATED** Series offer:

Higher water quality and longer life of the filtration system, due to a lower shear water velocity as the raw water passes through the filter, to allow for more contact time and more interaction with the extensive surface area of the filters.

The filters will outperform available filtration solutions in all turbidity applications including insoluble scale, Fe³⁺, bacterial iron slime, colloidal solids, silt, rust, and other particle filtration.

Each filter comes with a unique handle designed top cap for lightweight and easy removal, a bag for proper disposal, and a double o-ring bottom connection into the **WATCH[®] Cartridge Filter** plumbing adapter for the 2.5" plumbing connections and 1¼" flow rates.



The **Double Pleated Filtration Series** are offered in double pleated layers for extended life and use, with filtration levels of 5, 10 and 20 microns, each with a larger pre-filtration layer on the outside and the smaller on the inside, to extend filtration level contamination.

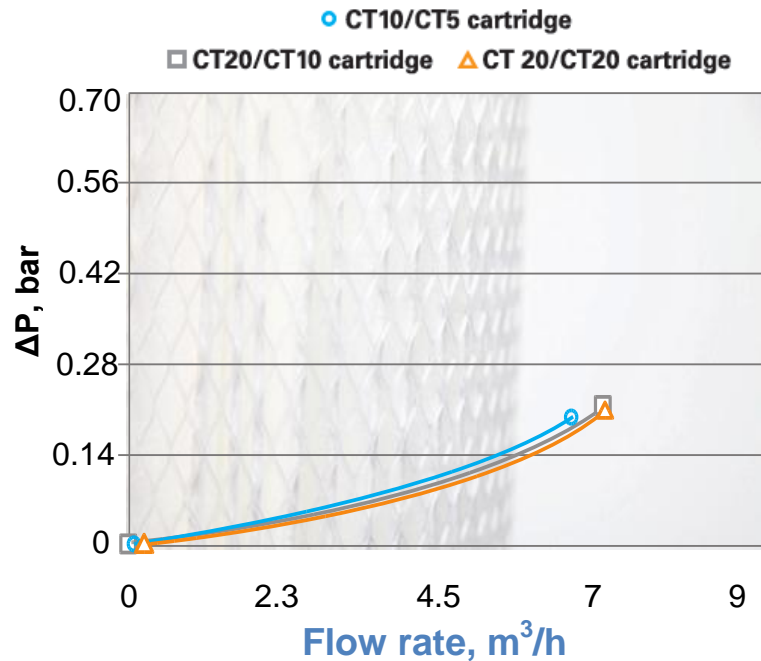

3 filter configurations:

- 5 micron inner filter, outer 10 micron pleated pre-filter layer
- 10 micron inner filter, outer 20 micron pleated pre-filter layer
- 20 micron inner filter, outer 20 micron pleated pre-filter layer

Based on testing performance:

- 7 m³/h flow rate, pressure loss through the filters is less than 0.21 bar
- 2.3 m³/h flow rate, pressure loss through the filters is less than 0.07 bar

ONLY CARTRIDGE
THE FILTER YOU NEED



Note that while testing was performed under standard laboratory conditions, actual performance may vary.

TYPE: UNIQUE Filtration Series

The **UNIQUE Filtration Series** are offered in double pleated layers for extended life and use, with a unique filtration solution, each with a larger filtration layer on the outside and the smaller on the inside, to extend filtration level contamination.

WATCH's Cartridge Filter series of pleated filter cartridges features a thermally bonded blend of micro-glass fibers & cellulose infused with **UN**-alumina fibers in a non-woven matrix that creates an electro positive charged depth filter media. When assembled into a pleated cartridge, our solution offers a unique combination of efficiency, capacity, flow rate & low pres-sure drop at levels unmatched in today's filtration marketplace. In addition, all filter cartridges are assembled using only FDA-compliant materials.

Applications:

- Primary Filtration in lieu of micro-porous membranes
- Make Up Water (particulate, microbial control)
- Polishing Filters (carbon fines, emulsified oil removal)
- RO Pre-filtration (SDI reduction)
- Process Water (turbidity, particulate, colloidal suspensions)
- Waste Water (organics, proteins, dyes)
- Cooling Towers, Chill Water Loops (iron removal)

Materials of Construction:

Media: **UN** - Al™ Media

Polypropylene (pre-filter layer)

Support: Polypropylene, Hot Melt

O-rings: Buna-N

Operating Conditions:

Temperature: 4 - 66°C (39 -150°F)

pH Range: 5 to 10

		CT20/UN	CT20/UN-AG	CT20/UN PAC-AG
Surface Area	m ²	4.1	4.1	4.1
Dirt Holding Capacity	KG	4.0	4.6	4.9
Efficiency w/A2 Fine Test Dust (Ratio)		>35,000	>35,000	>35,000
Dimensions	cm	15.25x76	15.25x76	15.25x76
Suggested Flow Rate	m ³ /h	5	5	5
Maximum Flow Rate	m ³ /h	8	8	8

3 filter configurations, each with a 20 micron pre-filter:

- **UN**-Al™ white
- **UN**-Al™ with Agion® Biostat,
- PAC version of **UN**-Al with Agion® Biostat

Based on testing performance:

- 8.0 m³/h flow rate, pressure loss through the filters is less than 0.55 bar
- 2.3 m³/h flow rate, pressure loss through the filters is less than 0.07 bar.

Retention Characteristics:

- Silt Density Index (SDI) < 0.5
- >99.99% Efficiency at 0.2 microns (latex spheres)
- >4 LRV Cyst Retention
- >5 LRV Klebsiella terrigena Retention
- <0.01 NTU until Terminal ΔP: 2.4 bar (35 psi)
- Dirt Holding Capacity: 883 g/m² (82 g/ft²)
- >757,000 liters or 200,000 gallons treatment capacity (third party testing)

Type	Flow Rate (lpm)	Type of Water	Turbidity In	Turbidity Out	SDI ₁₅ A
CT - 20/ UN	4	A2 Dust in RO WATER	350.00	<0.01	0.2 ± 0.3 ¹
		Municipal Tap Water	0.57	<0.01	0.2 ± 0.3 ¹
CT - 20/ UN - AG	4	A2 Dust in RO WATER	350.00	<0.01	0.2 ± 0.3 ¹
		Municipal Tap Water	0.54	<0.01	0.2 ± 0.3 ¹
CT - 20/ UN - PAC- AG	4	A2 Dust in RO WATER	350.00	<0.01	0.2 ± 0.3 ¹
		Municipal Tap Water	0.57	<0.01	0.2 ± 0.3 ¹

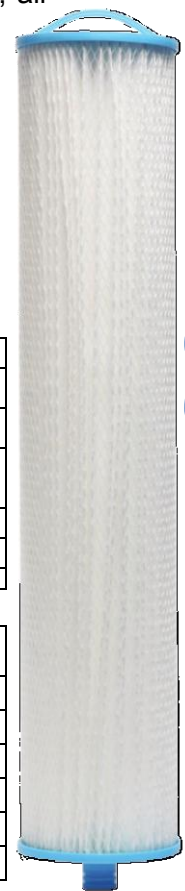

THE ONLY CARTRIDGE FILTER YOU NEED

○ CT20 / UN-AG Cartridge □ CT20 / UN-AG Cartridge
△ CT20 / UN-PAC AG Cartridge

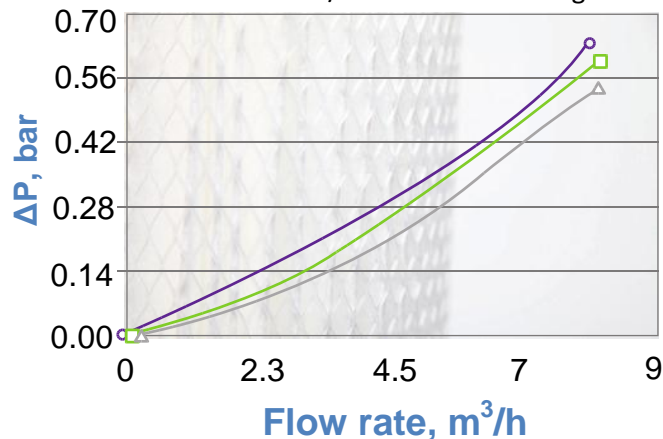

TYPE: CARBON Filter

ONLY simplifies the filtration process and offers a variety of options to suit your needs. The **CARBON BLOCK** Filtration Series offer:

WATCH Cartridge Filter is a direct replacement for small and inefficient 2.5" or 4.5" housings, or expensive Stainless Steel cartridge housings, specifically designed for Residential, Light Commercial, and Commercial installations and applications.

The **Carbon** Filtration Series incorporates **carbon block** filter technology that is highly effective at reducing bad taste and odor from potable drinking water. The filters are made using high performance coconut shell carbon, which has more micro pores compared to other types of carbon.

Coupled with a unique binder system, these carbon block filters deliver a product with superior adsorption capacity and kinetic dynamics. These high capacity filters provide cost effective water filtration solutions in a filter size and configuration that offers ease-of-use, extended service life and capacity, at low pressure loss.

All components and materials are FDA approved, Manufactured from NSF/ANSI-61 Certified Coconut Shell carbon, and are California Prop 65 Compliant.

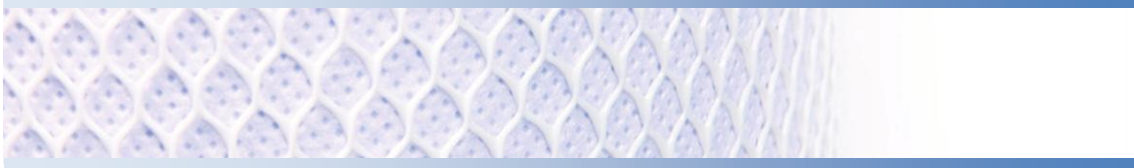

THE ONLY CARTRIDGE FILTER YOU NEED



Features:



- High-performance carbon
- Unique binder system
- Proprietary manufacturing process
- Outer Wrap of Polypropylene
- Netting of Polyethylene

Benefits:

- Exceptionally low pressure drop
- High dirt holding capacity
- Excellent contaminant reductions

Application:

Ideal for Residential, Food Service, Commercial and Industrial applications Effective at reducing unwanted bad taste and odor, along with chlorine taste and odor from potable drinking water Ideal as polishing or pre-filters in applications requiring fine filtration and high capacity

Available in two filter configurations:

- 3 Micron Carbon Block, High Capacity*
- 20 Micron **Carbon Block**, High Porosity/Low Pressure Drop

* Nominal 3 micron rated filter has been 3rd party tested to treat 1000m³ of water @ 1.6 m³/h with 2 ppm of chlorine.

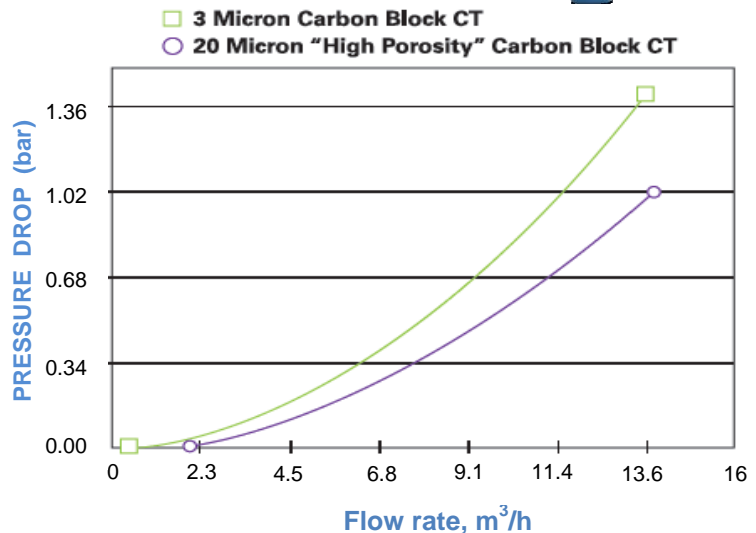

TYPE: **WOUNDED** Cartridge Filter

ONLY simplifies the filtration process and offers a variety of options to suit your needs.
The **WOUNDED** Filtration Series offer:

This **WOUNDED** Filtration Series offers a combination filter composed of an outer layer of Polypropylene String with a Melt blown Polypropylene Core. These dual media filters provide a cost effective, extended-life product capable of capturing a broad range of particulates with high service flow rates up to 15m³/h with less than 1 bar.



Features:

- Outer pre-filter manufactured using 100% polypropylene yarn
- Precision pattern captures 20 or 50 microns or larger
- Extends service life of inner filter
- Outer filter captures fine sediment, sand, silt, rust and scale particles.
- Melt blown inner filter manufactured using thermally bonded polypropylene fibers
- Minimal pressure drop
- Consistent downstream flow w/out fiber migration

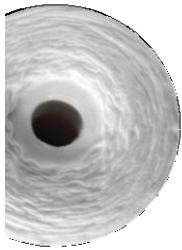

Application:

Potable water	Food/beverage
Pre RO	Fine chemicals
Electronics	Metal finishing
Plating solutions	Oxidizing agents
Corrosive fluids	Gases
Concentrated acids and alkali	

Available in two filter configurations:

- 20 Micron String Wound Outer Layer with a 5 micron **Meltblown** PP Core
- 50 Micron String Wound Outer Layer with a 20 micron **Meltblown** PP Core

Performance claims are based on independent lab results and manufacturer's internal test data.

Actual performance is dependent on influent water quality, flow rates, system design and applications. Your results may vary.

Micron ratings based on 85% or greater removal of a given particle size.

Estimated capacity using 2 ppm free chlorine with greater than 90% reduction.

Performance data has not been tested validated by NSF.

Flush new cartridges until water runs clear prior to use.

Do not use with water that is microbiologically unsafe or of unknown quality without adequate disinfection before or after the system.

Benefits:

- Microorganism resistant
- NSF/ANSI-61 component
- Nominally rated as stated
- High purity
- Excellent chemical resistance
- High dirt holding capacity
- Graded density



THE ONLY CARTRIDGE FILTER YOU NEED

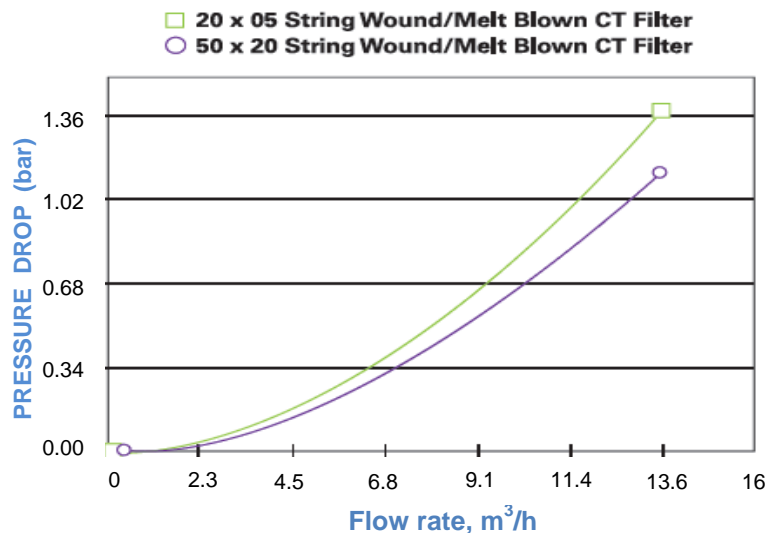

TYPE: **PLEATED** Filtration Series

ONLY simplifies the filtration process and offers a variety of options to suit your needs.

The **PLEATED** Series offer:

The **PLEATED Filtration Series** are pleated Polypropylene cartridges, with multiple levels of filtration flexibility:

The pleated cartridges are for service flow rates up to 34 m³/h, with low pressure drop of less than 1 bar, are 100% cellulose free media, and cleanable 5 micron and up.

The **Pleated** Active Carbon (PAC) cartridge is for a service flow rate of 34 m³/h with a removal capacity of 530 m³, with a 90% chlorine reduction. This dramatically improves the quality of water by reducing chlorine, bad taste, foul odors and sediment.

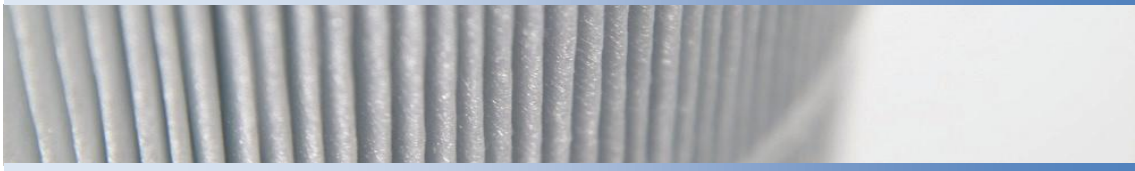

Install **ONLY** filters in parallel to achieve higher flow rates or in a series for step filtration, allowing various micron ratings in each Cartridge Tank. This makes **ONLY** filters an attractive option for those applications that require versatility.

4 filter configurations:

- 20 micron
- 5 micron
- 1 micron absolute
- Activated Carbon (PAC) impregnated cartridge.

Low Pressure Drop

ONLY filters are designed to minimize pressure drop by using 2" pipe fittings and large diameter center tubes. (see chart for pressure drop data using pleated cartridges)

Installation and Replacement:

The **ONLY** Cartridge Filtration System is designed to be simple and easy to install and service.

In combination with our patent pending no tools necessary snap-ring design and Filter Cartridge solution, **ONLY** makes it fast and easy.

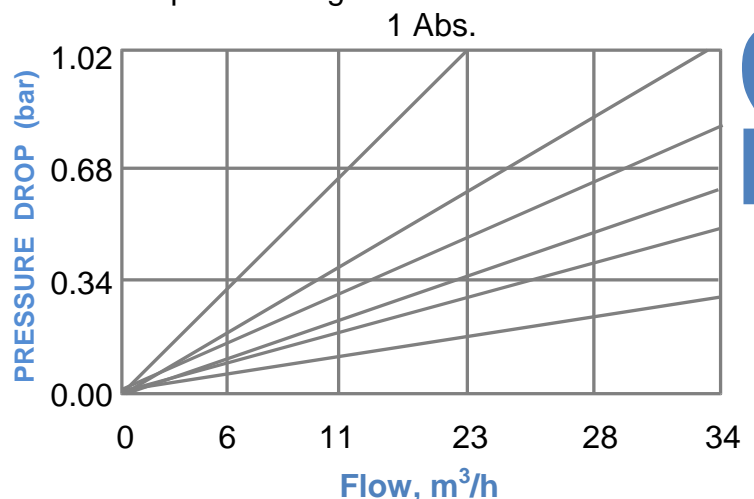

TYPE: MELTBLOWN Filtration Series

ONLY simplifies the filtration process and offers a variety of options to suit your needs.

The **MELTBLOWN Pleated Series** offer:

Higher water quality and longer life of the filtration system, due to a lower shear water velocity as the raw water passes through the filter, to allow for more contact time and more interaction with the extensive surface area of the filters.

Each filter comes with a unique handle designed top cap for lightweight and easy removal, and a bag for proper disposal, along with a double o-ring bottom connection into the WATCH Cartridge Filter plumbing adapter for the 4.5" plumbing connections and 2" pipe size flow rates.

Specifications	
Maximum flow rate (Pleated)	34 m ³ /h
Max. flow rate (1 Micron Absolute)	11.3 m ³ /h
Max. flow rate (Depth)	22.7 m ³ /h
Max. flow rate (Activated Carbon)	3.4 m ³ /h
Cartridge end caps	Glass reinforced PP
O-rings (Cartridge)	EPDM

THE ONLY CARTRIDGE FILTER YOU NEED



The **Meltblown Polypropylene Depth**, also known as the **Meltblown Filtration Series**, are ideal for reduction of soft particulate and high service flow rates up to 22.7 m³/hr.

ONLY MELTBLOWN Filtration Series are tough, durable and designed for a variety of residential and commercial uses, including:

Common Applications:

- Whole house filtration
- Commercial filtration
- Industrial filtration
- Pre-filtration for RO equipment
- Community water systems
- Sea water applications due to their non-corrosive construction
- Replacement for bag filters with more filter area
- A convenient alternative to multiple cartridge filters
- Water for livestock and poultry

	MELTBLOWN	PLEATED	PLEATED
Media	PP or PE	PP or PE	Activated carbon
End caps	PP + FG	PP	PP + FG
Center tubes	PP	PP	PP
Maximum flow rate (m ³ /h)	34	23	3.4
Maximum temperature	52°C/125°F	52°C/125°F	52°C/125°F
Maximum ΔP (bar)	2.1	2.75	2.1
Chemical resistance	Excellent	Excellent	Not a factor (for water only)
Length (media)	26 -¼"	26 -¼"	26 -¼"
O-rings (dual)	EPDM	EPDM	EPDM
Shipping weights (lbs)	5	5	5
Carton dimensions	7"x7"x31"	7"x7"x31"	7"x7"x31"
Micron ratings	1A, 5* 20**	5, 20	5

*Polypropylene fabric **Polyester fabric

Note: Flow rates are based on each specific application, micron ratings, solid contents and a number of factors. End user should consider these factors when selecting the filter housing (or number of filter housings) needed for their particular requirement.

Watch[®] Water GmbH

Fahrlachstr. 14 68165 Mannheim
 Telefon: +49 (0) 621 87951-0
 Telefax: +49 (0) 621 87951-99
 email: info@watchwater.de

17

Distributor:

TYPE: EASY Ultra Filtration

TECHNOLOGY THAT IS EASY TO UNDERSTAND.
 Water Savings - Environment Friendly - Innovative Design.

WATCH[®] introduces its **EASY Ultrafiltration (Easy-UF)** Vessel system. The WATCH[®] **Easy-UF** offers 0.02 micron filtration at service flow rates up to 2.7 m³/h, just another tool in the water treatment tool box. Another example of the innovative thinking you've come to expect from WATCH[®].

Utilizing WATCH[®] patented and industry exclusive liner design, the internal UF module treats colloids, bacteria, cysts, viruses, turbidity, tannins, and other particles down to 0.02 micron size. The back-washable system, allows for multiple standard 2.5" top inlet connections, from standard back-washable control valves to in/out heads.

The high surface area UF bundles require normal line pressure to operate, low waste discharge when in backwash/cleaning mode, and offer low pressure drop with high service flow rates.

The WATCH[®] **Easy-UF** can be utilized as a final polishing stage or on water reclamation systems for Rainwater or Grey water, along with offering protection during power outages and intermittent power. The membrane is certified to NSF/ANSI 61 and the system is BioVir certified and tested for log reduction. The vessel also comes standard with a bottom drain opening for ease of drainage and cleaning purposes of the tank system.

Technology that is easy to understand and use, another innovation from WATCH[®].



The membrane is certified to NSF/ANSI-61 and the system is BioVir certified and tested for log reduction.



THE ONLY CARTRIDGE FILTER YOU NEED

This pressure vessel is tested and Certified to NSF/ANSI standard 61 and NSF/ANSI Standard 44 for materials and structural integrity requirements.

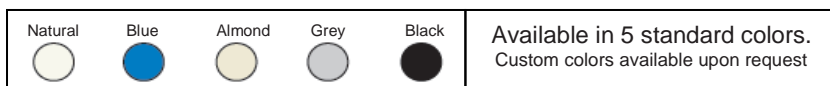

COMPONENT

Distributor:

MEMBRANE:

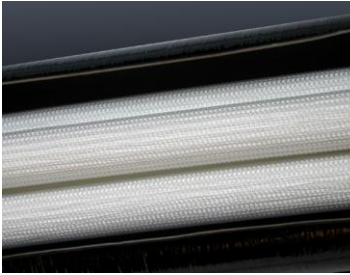

Our patented polysulfone-based Outside/In Ultrafiltration Membrane is designed for turbidity, cyst reduction and fine sediment filtration applications and is certified to NSF/ANSI-61. The membrane operates with flow from the outside-to-inside, with benefits of minimized risk of deep clogging, simple cleaning of the membrane surface with water and/or air, and a high area volume ratio that allows for a compact design. The membrane is non-biodegradable, and has superior mechanical strength. The WATCH[®] **Easy Ultrafiltration** Vessel System provides point-of-entry (POE) filtration, for safe and clean water at every faucet.

MEMBRANE:

- Patented Outside/In Polymeric Membrane
- Filtration Module that is NSF/ANSI-61, EPA, ACS and CDHS certified.
- BioVir certified and tested system for log reduction of Bacteria and Virus.
- **Four bundles** of 0.02 micron filtration.
- High performance flow rates, up to 2.7 m³/h.
- Standard 2.5" top inlet opening for connection with standard back-washable control valves to in/out heads, for metered service.
- Standard bottom drain and opening for drainage and cleaning purposes of the system.
- No special controller or programming needed.
- Economical POE packaging that looks like standard water treatment equipment.
- Low waste water discharge used when cleaning.
- Designed for cyst reduction, turbidity, and fine sediment filtration applications.
- Protection during power outages and intermittent power.

APPLICATIONS:

- Grey Water and Rainwater use, catchment, and recycling.
- Tannin removal.
- RO Pre-filter.
- Polishing post filter filtration.
- Colloid removal.
- Bacteria, cyst and virus removal.

TECHNICAL INFORMATION:

- Continuous flow at 2.3 m³/h filtration at 0.02 microns.
- 4.4 log reduction of Bacteria.
- 2.4 log reduction of Virus.
- 2.0 log (est) reduction of Cyst.
- 100,000 MWC

FILTRATION LEVEL:

- 0.02 micron.
- Operating Temperature: 2°C to 38°C.
- Operation Pressure: 0.7 to 6.8 bar.
- Continuous Flow Rate: 2.3 m³/h.
- The system provides a treated flow of up to 2.7 m³/h at 25°C and 4.1 bar.
- Membrane is Certified to NSF/ANSI-61.
- Raw Water Specification:
 1. Pre-filtration: 5 microns or less.
 2. Chlorine: 1.0 ppm maximum for continuous flow (up to 2000 ppm for cleaning only).
 3. Iron: Less than 0.30 ppm.
 4. Manganese: Less than 0.05 ppm.
 5. Silt Density Index: Less than 6.0
 6. pH: 3 to 11.
 7. Pressure Decay Test (PDT) is required upon installation.

BACK WASH:

Back Flush: Once per day (5 minutes at 0.16 to 0.46 m³/h).
 Drain Flush: Once per week (2 minutes at 1.14 m³/h).

**This product is not certified as a microbiological purifier and should not be applied as a stand-alone disinfection solution for microbiologically unsafe water.*

